

TDC Power Products Co.,Ltd
Cheng Yen Electronic Co.,Ltd

SA8E-320-0800WPMT

INPUT VOLTAGE : 220~240VAC
OUTPUT VOLTAGE : 32VDC

SWITCHING POWER SUPPLY SPECIFICATION REV:A

Drawing:

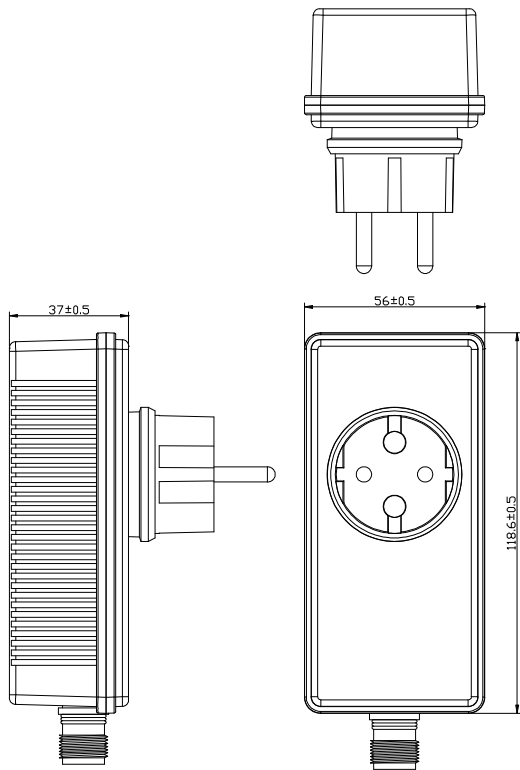

ELECTRONICAL SPECIFICATION

INPUT VOLTAGE : 220~240 Vac INPUT RANGE VOLTAGE 200~264 Vac
 INPUT FREQUENCY : 50 Hz INPUT RANGE FREQUENCY 47~53 Hz
 INPUT CURRENT : 0.2 Amp. rms. at 240 Vac
 INRUSH CURRENT : 80 Amp. peak at 240 Vac
 Tested At Max. load 25°C , Cold start

OUTPUT VOLTAGE : 32 V
 REGULATION : ±5 %
 MIN. LOAD CURRENT : 0 A MAX LOAD CURRENT: 0.8 A
 LOOP 1 LOAD CURRENT : 0.2 A
 LOOP 2 LOAD CURRENT : 0.2 A
 LOOP 3 LOAD CURRENT : 0.2 A
 LOOP 4 LOAD CURRENT : 0.2 A
 TOTAL OUTPUT : 20 W
 POWER EFFICIENCY : 80% Min. at 230 Vac 50 Hz, Max. load.
 POWER FACTOR ≥ 0.80 at 230 Vac /50 Hz Full Load .Meets IEC61000-3-2 Harmonic Class C
 OVER CURRENT PROTECTION , SHORT CIRCUIT PROTECTION(LATCHED SHUTDOWN)
 TOTAL POWER PROTECTION : 60 W
 OVER VOLTAGE PROTECTION : 36 Vdc Max.
 TRANSFORMER BUILD 8 FUNCTIONAL CONTROLLER
 1.COMBINATION 2.IN WAVES 3.SEQUENTIAL 4.SLO GLO
 5.CHASING/FLASH 6.SLOW FADE 7.TWINKLE/FLASH 8.STEADY ON

MECHANICAL SPECIFICATION

Dimensions : 118.6(L) * 56(W) *37(H)mm (Tolerance as drawing)
 Weight : 310 g Max.
 Operating Temperature : 0°C To 40°C
 Storage Temperature : -15°C To 50°C
 Relative Temperature : 40°C ± 2°C
 MTBF: 50,000 hrs to MIL-HDBK-217F Warranty: 2 years

Input Cable : DIRECT PLUG-IN

Output Cable : 5Pin Φ2.35 waterproof
Female socket BK

LABEL: SIZE:40*102.6mm



STANDARD

Safety:EN61347-1,EN61347-2-11,EN61347-2-13; EMC:EN61547,EN55015,EN61000-3-2,EN61000-3-3.

RELATIVE HUMIDITY 85% RH. Non-condensing

INNER BOX:

Material: WEB
BOX: 150*80*95mm

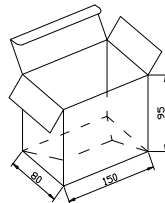

CARTON: 470*420*400 mm

Material:K=A No Nail
 QTY: 60 PCS
 N.W.: 18.6 KGS
 G.W.: 21.0 KGS
 MEAS: 2.79 CUFT

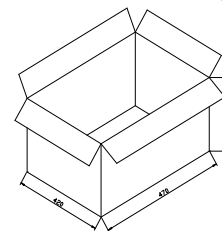

photo

