

TDC Power Products Co.,Ltd
Cheng Yen Electronic Co.,Ltd

SA8E-280-0430P

INPUT VOLTAGE : 220~240VAC
OUTPUT VOLTAGE : 28VDC

SWITCHING POWER SUPPLY SPECIFICATION REV:A

Drawing:

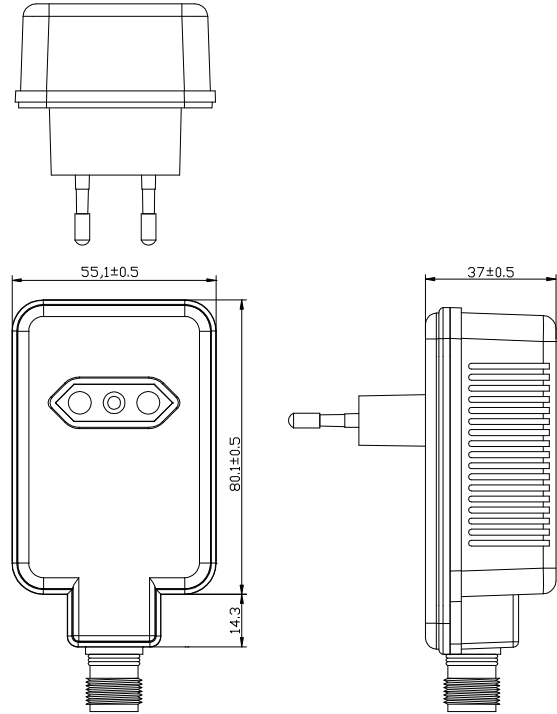

ELECTRONICAL SPECIFICATION

INPUT VOLTAGE : 220~240 Vac INPUT RANGE VOLTAGE 200~264 Vac
 INPUT FREQUENCY : 50 Hz INPUT RANGE FREQUENCY 47~53 Hz
 INPUT CURRENT : 0.1 Amp. rms. at 240 Vac
 INRUSH CURRENT : 50 Amp. peak at 240 Vac
 Tested At Max. load 25°C , Cold start

OUTPUT VOLTAGE : 28 V
 REGULATION : ± 5 %
 MIN. LOAD CURRENT : 0 A
 MAX. LOAD CURRENT : 0.43 A

POWER FACTOR ≥ 0.85 at 230 Vac /50 Hz Full Load .Meets IEC61000-3-2 Harmonic Class C
 RIPPLE AND NOISE : 1.3 Vp-p Max. At 240 Vac, 50 Hz, Max. load 25°C
 NOISE TEST BANDWIDTH : 20 MHz

Each output bypassed by a 10uF electrolytic capacitor parallel with a 0.1uF ceramic capacitor to GND.

LINE REGULATION : INPUT = 220 ~ 240 Vac,output loaded at Max. load.
 REGULATION = ± 5 %

TOTAL OUTPUT : 12 W
 POWER EFFICIENCY : 77% Min. at 220~240 Vac 50 Hz, Max. load.
 OVER CURRENT PROTECTION , SHORT CIRCUIT PROTECTION
 TOTAL POWER PROTECTION : 45 W
 OVER VOLTAGE PROTECTION : 33 Vdc Max.

MECHANICAL SPECIFICATION

Dimensions : 94.1 (L) * 55.1(W) * 37(H)mm (Tolerance as drawing)
 Weight : 220 g Max.
 Operating Temperature : 0°C To 40°C
 Storage Temperature : -15°C To 50°C
 Relative Temperature : 40°C ± 2°C
 MTBF: 50,000 hrs to MIL-HDBK-217F Warranty: 2 years

Input Cable : DIRECT PLUG-IN

Output Cable : 2Pin Φ2.35 waterproof
Female socket BK

LABEL:
SIZE:34.6*44.6mm

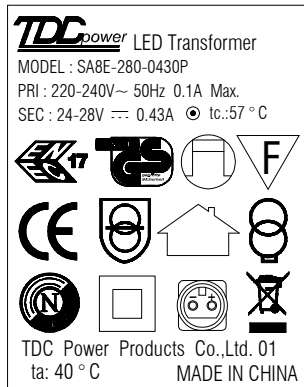

STANDARD

Safty:EN61347-1,EN61347-2-13. EMC:EN61547,EN55015,EN61000-3-2,EN61000-3-3.

RELATIVE HUMIDITY 85% RH. Non-condensing

INNER BOX:

Material: WEB
BOX: 110*60*90mm

CARTON: 460*320*290mm

Material:K=A No Nail
 QTY: 60 PCS
 N.W.: 13.8 KGS
 G.W.: 16.2 KGS
 MEAS: 1.5 CUFT

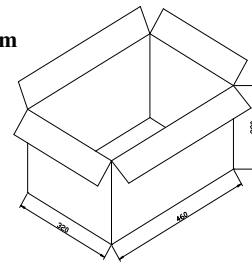
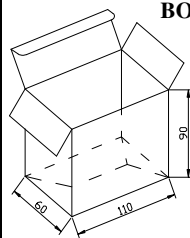

photo

