

SPECIFICATION

MECHANICAL:

1. Housing Material: Polycarbonate, UL 94V-2, NO Poison
2. Material Contact: 6U" Below Brass, 15U" Above Phosphor Bronze.
3. Contact area plated gold over 30U"/6U"/15U"/30U" and 50U", the other area plated gold over FU".
4. Contact area plated Nickel over 60U", the other area plated Nickel over 30U".
5. Housing Color: Transparent.
6. Operation Temperature: -40°c to 80°c.

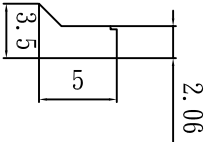
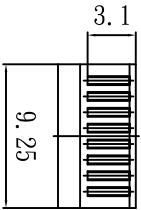
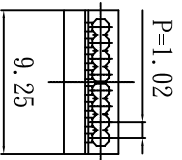

Insert

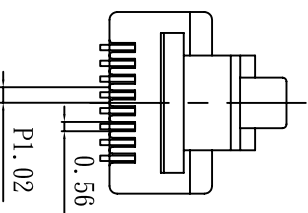
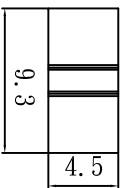
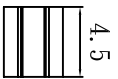
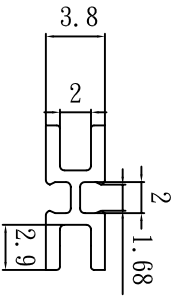

支架空間為2.21mm

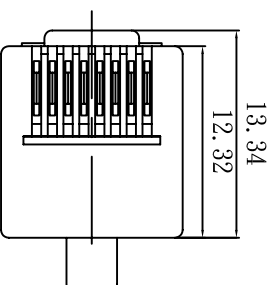
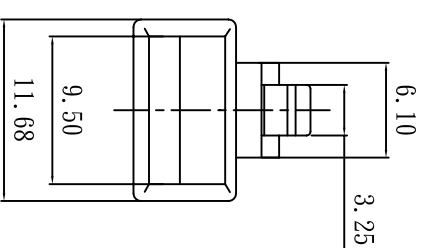
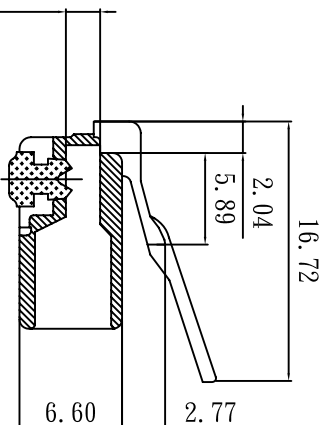
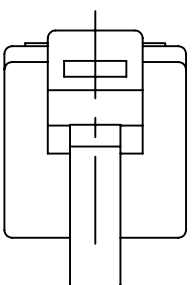

NOTE TOL: ±0.1

版本	A
----	---

3RD	繪圖	日期	2005/08/26	品名	S-8P8C F-L
單位	核對	日期		規格	斜度(3.5)三件式支架-2無線槽
比例	核准	日期		圖號	P8-S80-7

PMC 普萊格通訊電子有限公司

PLUG MASTER INDUSTRIAL CO., LTD

TEL: 86-769-87889195 FAX: 86-769-87889175