

SPECIFICATION

MECHANICAL:

1. Housing Material: Polycarbonate, UL 94V-2, NO Poison
2. Material Contact: 6U" Below Brass, 15U" Above Phosphor Bronze.
3. Contact area plated gold over 3U"/6U"/15U"/30U" and 50U", the other area plated gold over FU".
4. Contact area plated Nickel over 60U", the other area plated Nickel over 30U".
5. Housing Color: Transparency.
6. Operation Temperature: -40° c to 80° c.

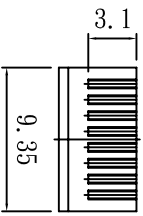
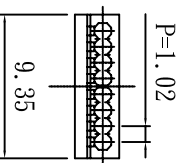

Insert

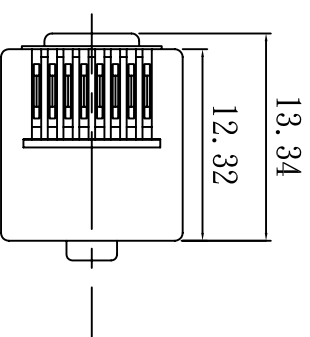
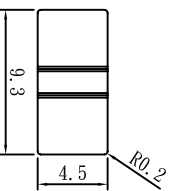
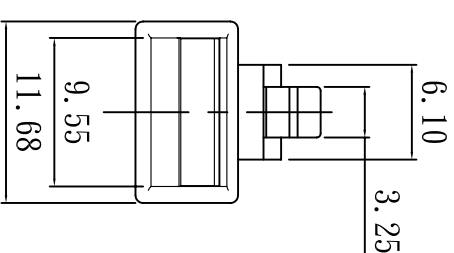
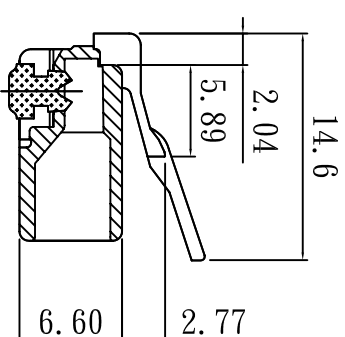
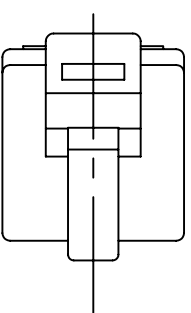
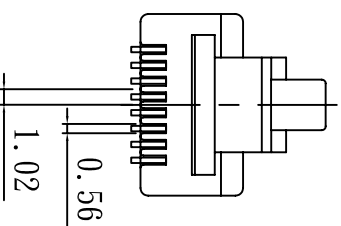
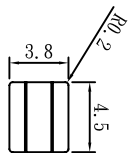
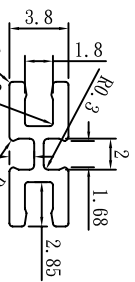
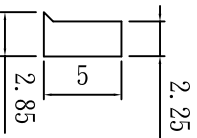

NOTE TOL: ±0.1

版本 B

3RD	繪圖	繪圖	日期	2007/08/15	品名	S-8P8C F
單位	核對	核對	日期		規格	斜度三件式2.85支架-2無線檔
比例	1/1	核准	日期		圖號	P8-S80-4

PMC 普萊格通訊電子有限公司
 PLUG MASTER INDUSTRIAL CO., LTD
 TEL: 86-769-87889195 FAX: 86-769-87889175