

## SPECIFICATION

### MECHANICAL:

1. Housing Material: Polycarbonate, UL 94V-2. NO Poison
2. Material Contact: 6U" Below Brass.  
15U" Above Phosphor Bronze.
3. Contact area plated gold over 30U"/60U"/150U"/30U" and 50U", the other area plated gold over FU".
4. Contact area plated Nickel over 60U", the other area plated Nickel over 30U".
5. Housing Color: Transparency.
6. Operation Temperature: -40°c to 80°c.

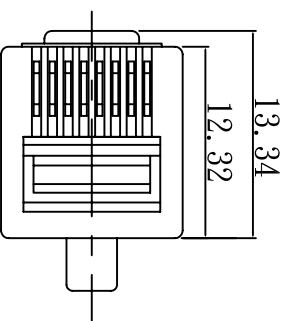
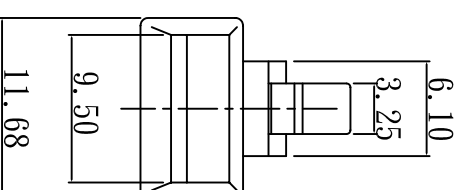
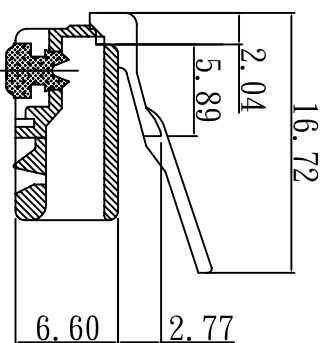
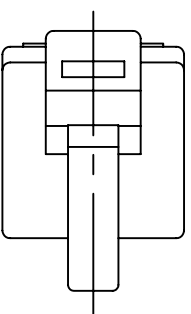
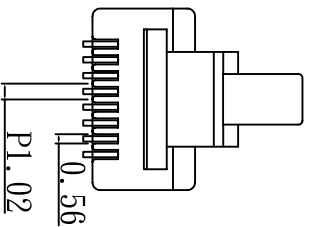
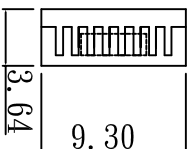
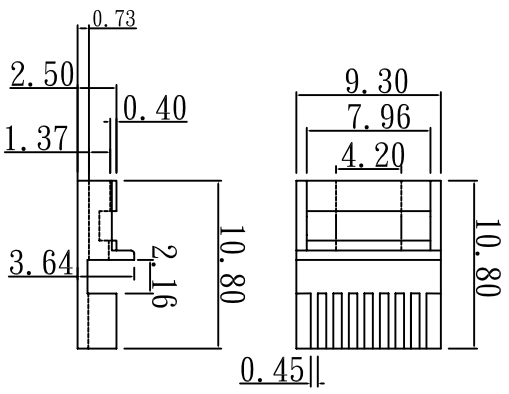

版本 A

3RD	繪圖	日期	品名	S-8P8C
單位	核對	日期	規格	F-L斜度 二件式 支架0.4
比例	核准	日期	圖號	P8-S78-2

*Whicby*

2005/07/11

廣宇專用NOTE TOL:±0.1

**PMC** 普萊格通訊電子有限公司

PLUG MASTER INDUSTRIAL CO., LTD

TEL: 86-769-87889195 FAX: 86-769-87889175