

SPECIFICATION

MECHANICAL:

1. Housing Material: Polycarbonate, UL 94V-2. NO Poison
2. Material Contact: 6U" Below Brass.
15U" Above Phosphor Bronze.
3. Contact area plated gold over 3U"/6U"/15U"/30U" and 50U", the other area plated gold over FU".
4. Contact area plated Nickel over 60U", the other area plated Nickel over 30U".
5. Housing Color: Transparency.
6. Operation Temperature: -40°c to 80°c.

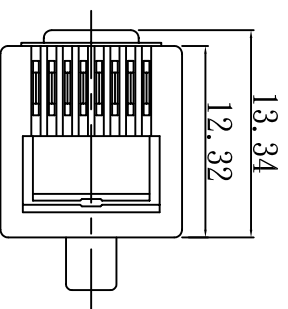
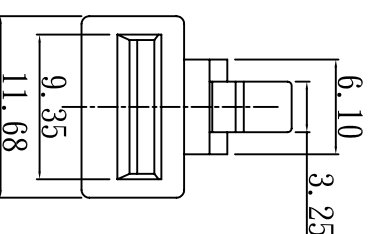
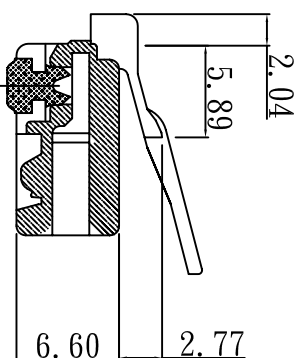
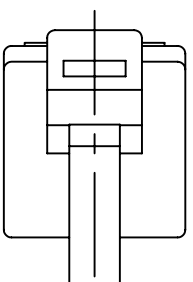
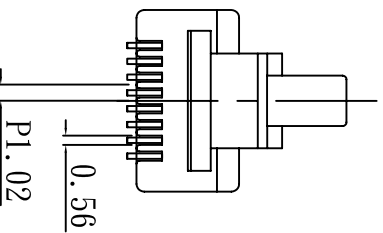
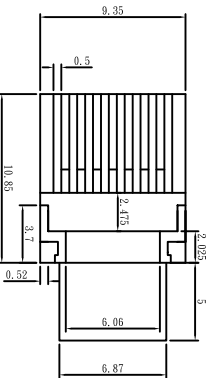
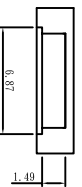
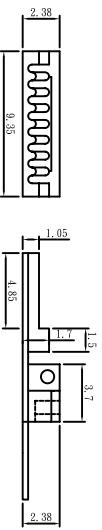
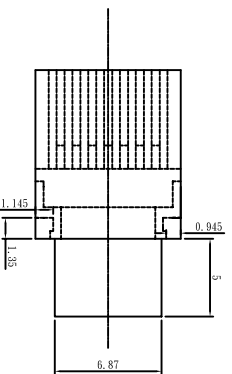

版本 B

3RD	繪圖	日期	品名
單位	核對	2005/07/23	S-8P8C
比例	核准	日期	規格
1/1		日期	F-L 二件式0.6
		圖號	P8-S58-3

PMC 普萊格通訊電子有限公司
 PLUG MASTER INDUSTRIAL CO., LTD
 TEL: 86-769-87889195 FAX: 86-769-87889175