

SPECIFICATION
MECHANICAL:

- Housing Material: Polycarbonate, UL 94V-2. NO Poi son
 UL 94V-0. NO Poi son
- Material Contact: Brass / Phosphor Bronze.
- Gold Plating: FU 2-3U 3U 6U 15U 30U 50U
- Housing Color: Transparency.
- SL: 1.0 1.2 1.5 2.0 2.5 3.0 3.5 4.0 4.5 5.0
- NO P8-039-9

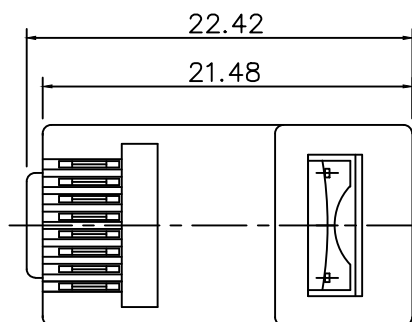
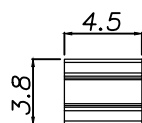
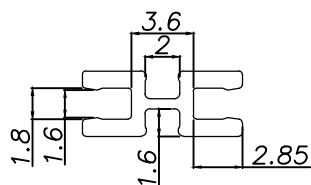
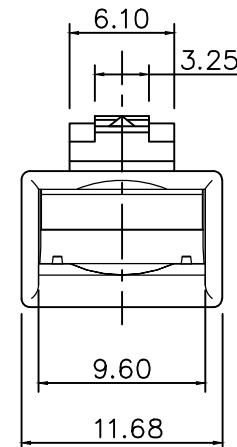
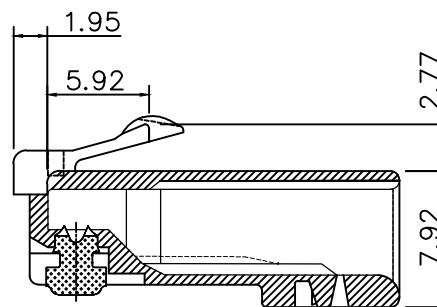
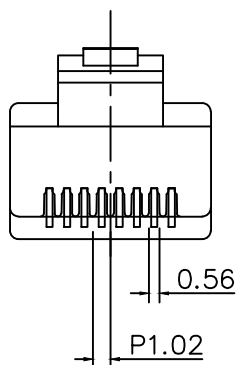
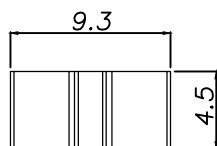
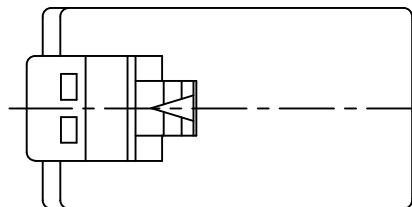
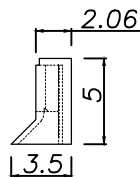
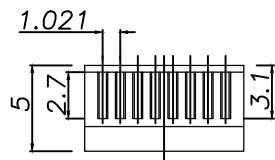
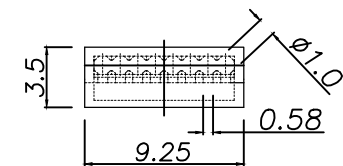

[Wire-Fixer]

Housing

客戶專用

NOTE TOL:±0.1

版本	A	繪圖	<i>Chicly</i>	日期	2010/3/24	品名	8P8C 2R-V
單位	m/m	核對	<i>Chris</i>	日期	2013/12/02	規格	٠' ر ٠ QLS ٠ x KP ٠
比例	1/1	核准	<i>Jason</i>	日期	2013/12/02	圖號	P8-039-9

PMC 東莞普萊格通訊電子有限公司
PLUG MASTER INDUSTRIAL CO., LTD
 TEL: 86-769-87889195 FAX: 86-769-87889175