

REVISIONS

LTR	DESCRIPTION	DATE	REV.	CHKD.	APVD.

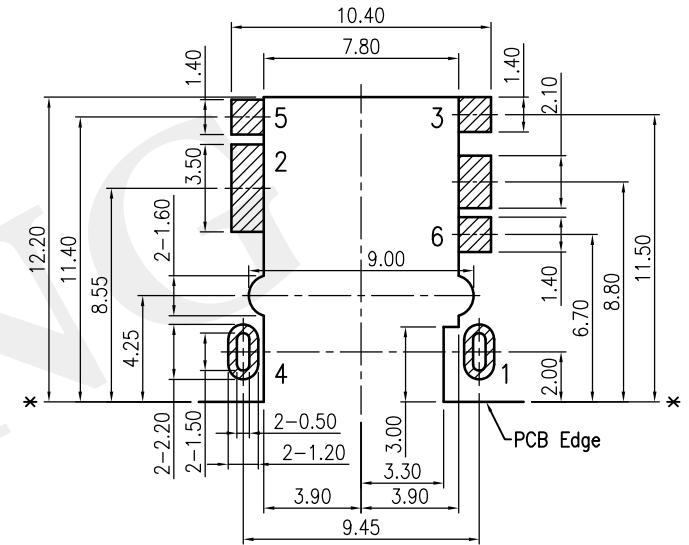
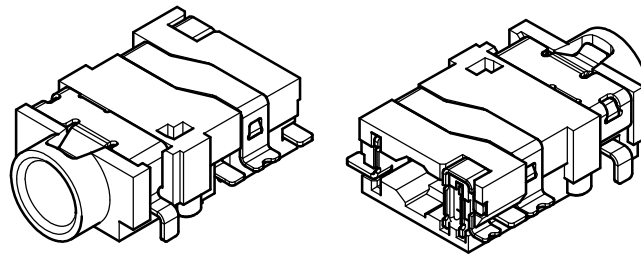
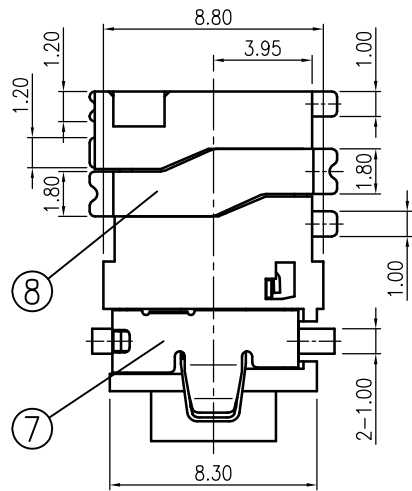

PCB Layout Dimension (Tolerance: ±0.05)
(Recommend min. Dimension)(Top View)

: Pad Area

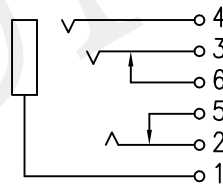
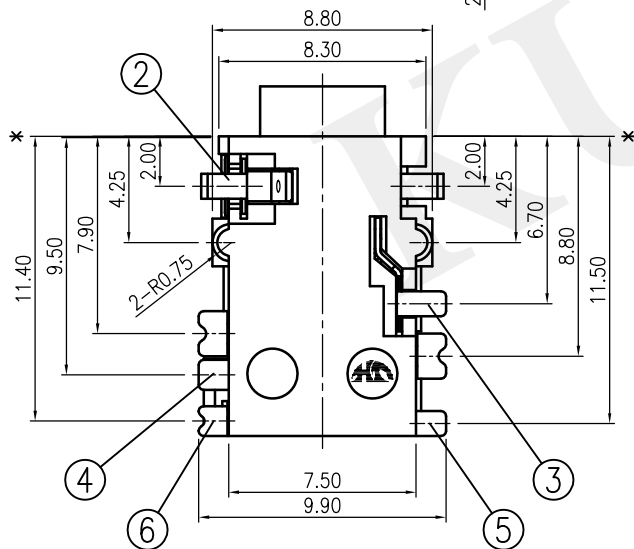
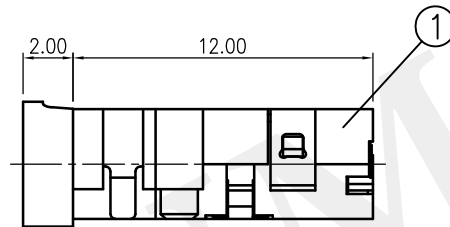
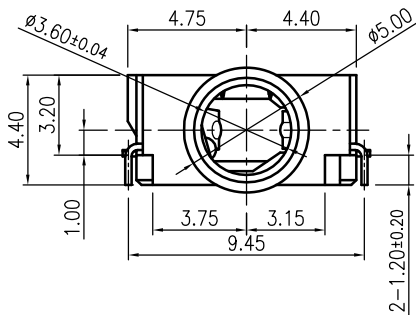

Circuit diagram

Note: Coplanarity of LTR. 3,4,5,6,8 : 0.10 Max.

8	TERMINAL	1	Brass	t=0.20
7	SLEEVE SPRING (1)	1	Copper Alloy	t=0.25
6	BREAK TERMINAL-1 (5)	1	Brass	t=0.20
5	RING SPRING-1 (3)	1	Copper Alloy	t=0.25
4	TIP SPRING (2)	1	Copper Alloy	t=0.25
3	BREAK TERMINAL-2 (6)	1	Brass	t=0.20
2	RING SPRING-2 (4)	1	Copper Alloy	t=0.25
1	HOUSING	1	High Temperature Thermoplastic UL 94V-0	

Please refer to color and plating combination list.

LTR	PART NAME	Q'TY	MATERIAL	REMARK
120~315	±0.5	DWN	江浩霆	DATE 2013.08.27
30~120	±0.35	DSND	江浩霆	DATE 2013.08.27
6~30	±0.22	CHKD	郭素玲	DATE 2013.08.27
BELOW 6	±0.16	APVD	郭遠峰	DATE 2013.08.27

DIMENSION	TOLERANCE	KUNMING ELECTRONICS CO.,LTD.		DWN.NO.	1/1
				A-35012A00T	001

SCALE 3.125/1
PROJECTION
UNIT: mm

NAME MINIATURE JACK
Right Angle Mid Mount(SMT+DIP)
CAT. NO.
KM35012A00__T__