

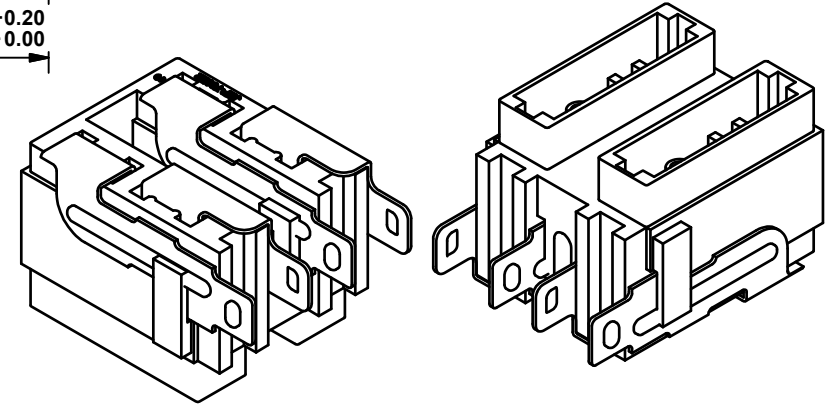

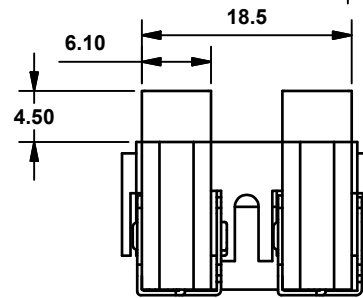

Recommended hole dimensions(terminal and housing)

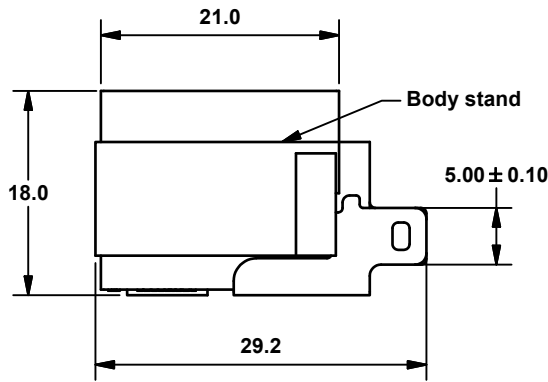
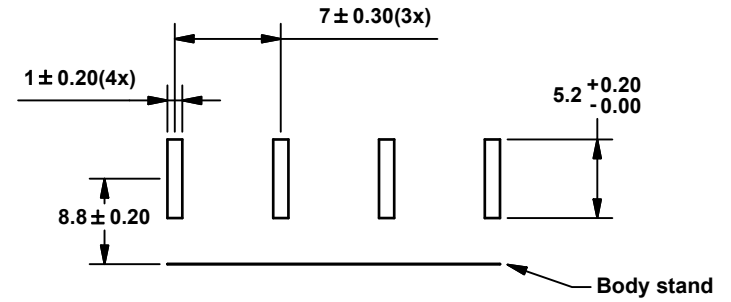
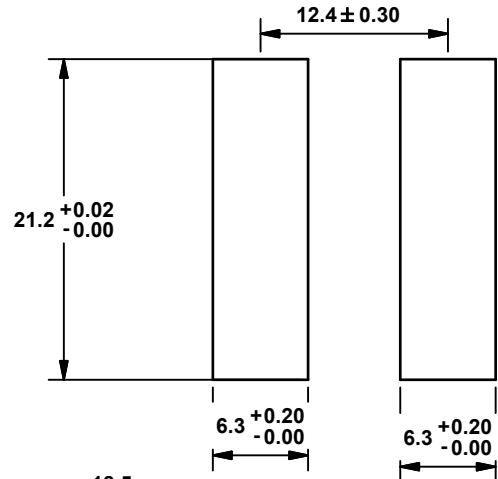
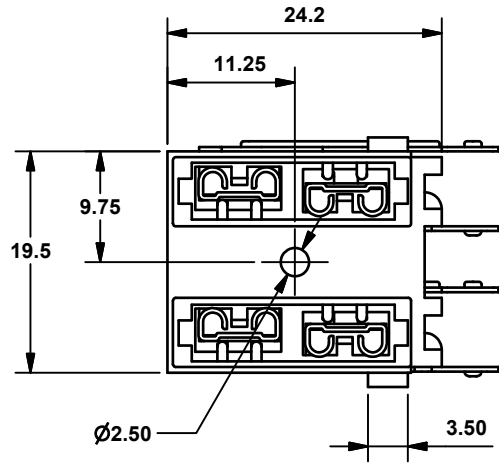
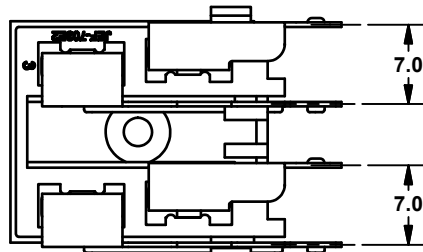

Panel mount Fuse Holder for ATU Fuse
 Specification:
 Electrical Rating:Max. 20A 32V
 Insulation Body:Nylon
 Contacts:0.4mm Brass Bright Tin plated



UNLESS OTHERWISE SPECIFIED DIMENSIONS ARE IN mm TOLERANCE DECIMALS ANGULAR X± 0.5 ± 2° XX± 0.25 DO NOT SCALE DRAWING		CUSTOMER NO.	JENN FENG ELECTRIC INDUSTRIAL CO., LTD
		DRAWN BY Tim	
 		CHECKED BY 	Panel Mount Fuse Holder
		APPROVED BY 	
P/N	C520200013N	DATE 2016/8/10	DRAWING NO. BA04032202
REV	C	SCALE	